



**CEAR**  
CENTRO DE ENERGIAS  
ALTERNATIVAS E RENOVÁVEIS  
UNIVERSIDADE FEDERAL DA PARAÍBA



# Programa de Pós-Graduação em Energias Renováveis

Meio Ambiente, Economia e Aproveitamento Energético

**Linhas de Pesquisa**

**Prof. Dr. Adriano da Silva Marques**

# LINHAS DE PESQUISA

## 1. Eficiência Energética e Termoeconomia

- Eficiências termodinâmicas em plantas industriais.
- Análise de sensibilidade financeira de custos energéticos.

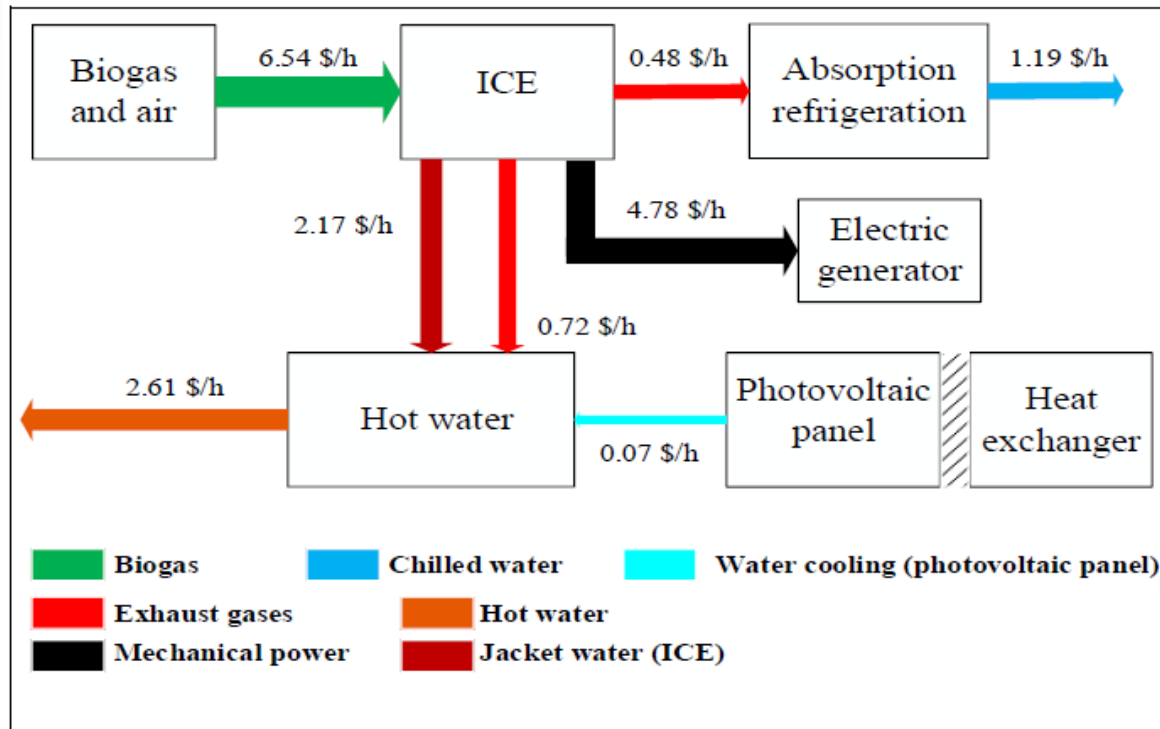

# LINHAS DE PESQUISA

## 1. Eficiência Energética e Termoeconomia

- Desenvolvimento de ferramenta computacional para diagnóstico e simulação energética e econômica.

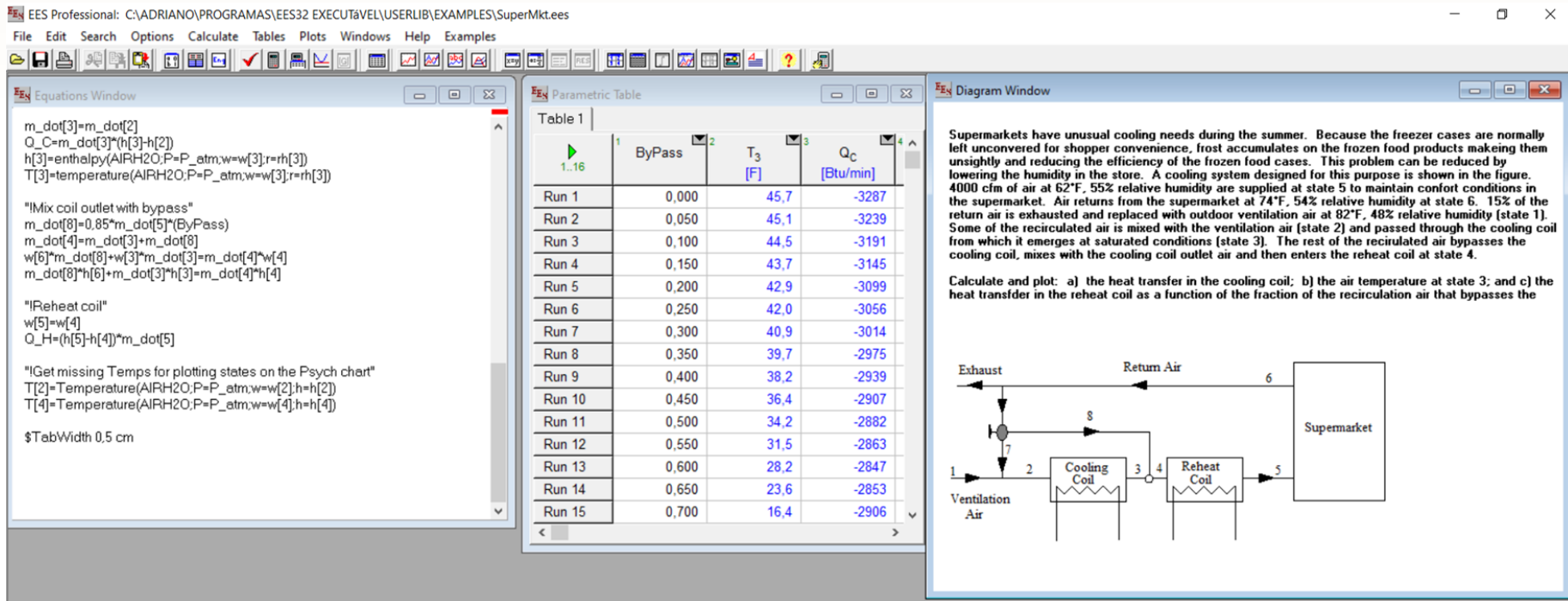

**EES Professional: C:\ADRIANO\PROGRAMAS\EES32 EXECUTÁVEL\USERLIB\EXAMPLES\SuperMkt.ees**

File Edit Search Options Calculate Tables Plots Windows Help Examples

**Equations Window**

```
m_dot[3]=m_dot[2]
Q_C=m_dot[3]*(h[3]-h[2])
h[3]=enthalpy(AIRH2O,P=P_atm,w=w[3],r=rh[3])
T[3]=temperature(AIRH2O,P=P_atm,w=w[3],r=rh[3])

"!Mix coil outlet with bypass"
m_dot[8]=0.85*m_dot[5]*(ByPass)
m_dot[4]=m_dot[3]+m_dot[8]
w[6]*m_dot[8]+w[3]*m_dot[3]=m_dot[4]*w[4]
m_dot[8]*h[6]+m_dot[3]*h[3]=m_dot[4]*h[4]

"!Reheat coil"
w[5]=w[4]
Q_H=(h[5]-h[4])*m_dot[5]

"!Get missing Temps for plotting states on the Psych chart"
T[2]=Temperature(AIRH2O,P=P_atm,w=w[2],h=h[2])
T[4]=Temperature(AIRH2O,P=P_atm,w=w[4],h=h[4])

$TabWidth 0.5 cm
```

**Parametric Table**

	1	2	3	4
	ByPass	T <sub>3</sub> [F]	Q <sub>C</sub> [Btu/min]	
Run 1	0,000	45,7	-3287	
Run 2	0,050	45,1	-3239	
Run 3	0,100	44,5	-3191	
Run 4	0,150	43,7	-3145	
Run 5	0,200	42,9	-3099	
Run 6	0,250	42,0	-3056	
Run 7	0,300	40,9	-3014	
Run 8	0,350	39,7	-2975	
Run 9	0,400	38,2	-2939	
Run 10	0,450	36,4	-2907	
Run 11	0,500	34,2	-2882	
Run 12	0,550	31,5	-2863	
Run 13	0,600	28,2	-2847	
Run 14	0,650	23,6	-2853	
Run 15	0,700	16,4	-2906	

**Diagram Window**

Supermarkets have unusual cooling needs during the summer. Because the freezer cases are normally left uncovered for shopper convenience, frost accumulates on the frozen food products making them unsightly and reducing the efficiency of the frozen food cases. This problem can be reduced by lowering the humidity in the store. A cooling system designed for this purpose is shown in the figure. 4000 cfm of air at 62°F, 55% relative humidity are supplied at state 5 to maintain confort conditions in the supermarket. Air returns from the supermarket at 74°F, 54% relative humidity at state 6. 15% of the return air is exhausted and replaced with outdoor ventilation air at 82°F, 48% relative humidity (state 1). Some of the recirculated air is mixed with the ventilation air (state 2) and passed through the cooling coil where it emerges at saturated conditions (state 3). The rest of the recirculated air bypasses the cooling coil, mixes with the cooling coil outlet air and then enters the reheat coil at state 4.

Calculate and plot: a) the heat transfer in the cooling coil; b) the air temperature at state 3; and c) the heat transfer in the reheat coil as a function of the fraction of the recirculation air that bypasses the

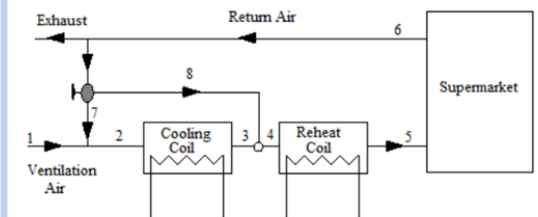

## 2. Sistemas de Refrigeração de Alto Desempenho

- Estudo avançado de sistemas acoplados de refrigeração não-convencionais.
- Desenvolvimento de bancadas de refrigeração.

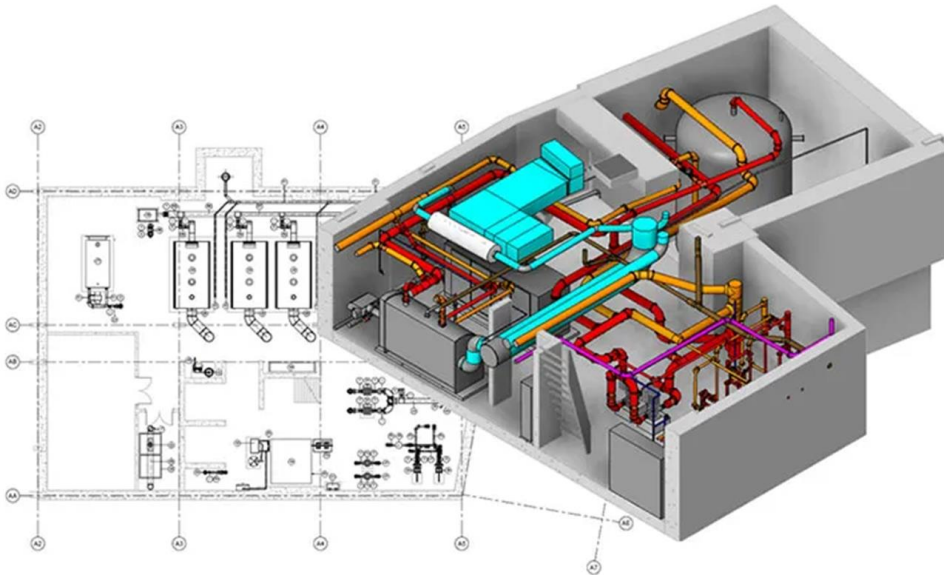

# LINHAS DE PESQUISA

## 3. Avaliação de Impactos Ambientais

- Diagnóstico ambiental por métricas globais (IPCC / CO<sub>2</sub>eq).
- Avaliação de Ciclo de Vida.

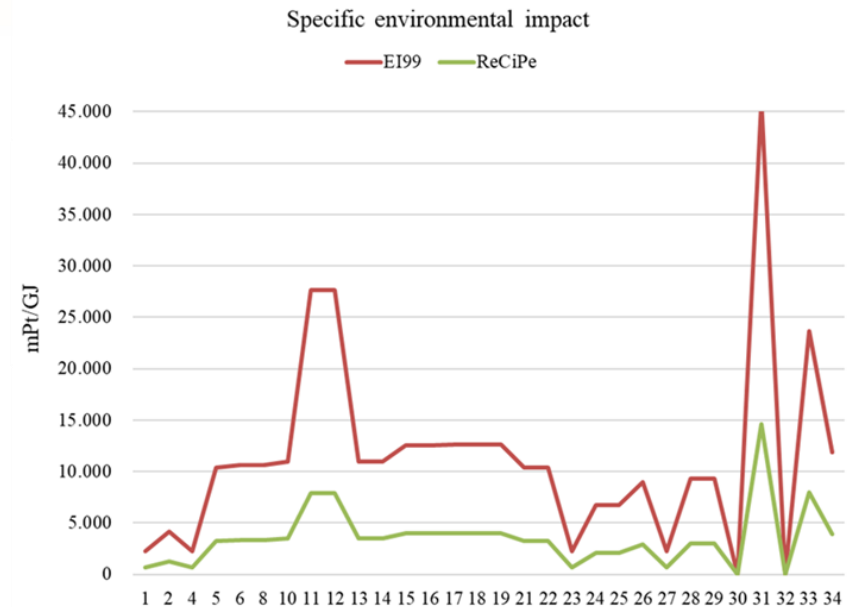
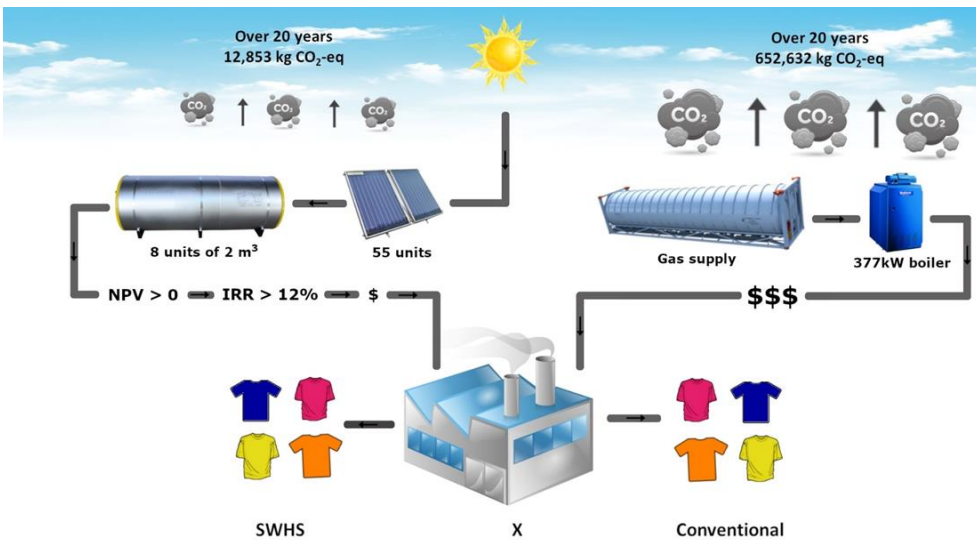

## 4. Otimização Energética e Termoeconômica

- Desenvolvimento e aplicação de nanopartículas a fluidos de trabalho para aumento de eficiência energética.

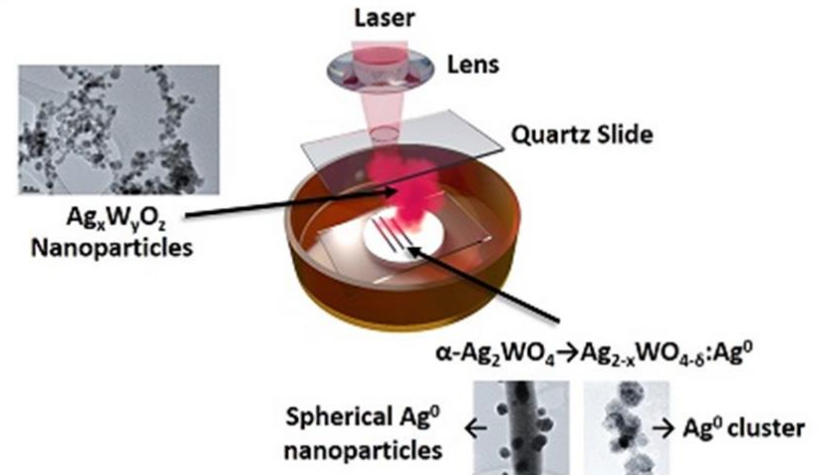

# LINHAS DE PESQUISA

## 5. Destilação Solar Convencional

- Projeto e construção de DSC's de baixo custo.
- Desenvolvimento de técnicas e de nanomateriais para aumento da eficiência de DSC.



# LINHAS DE PESQUISA

## 6. Avaliação Energética e de Emissões em MCI

- Simulação computacional (GT-POWER).
- Estudo de curvas de torque e potência.

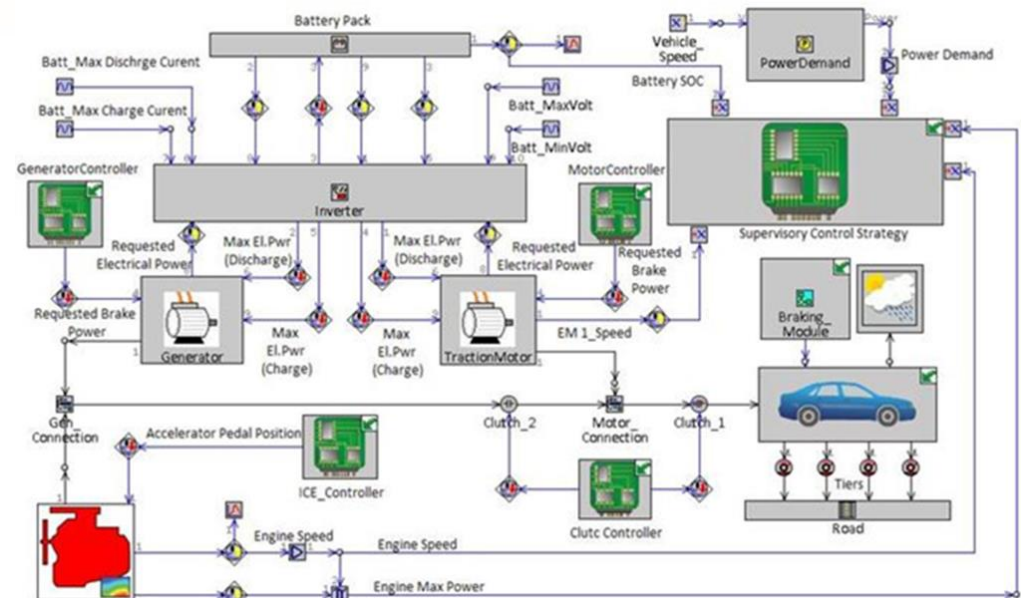
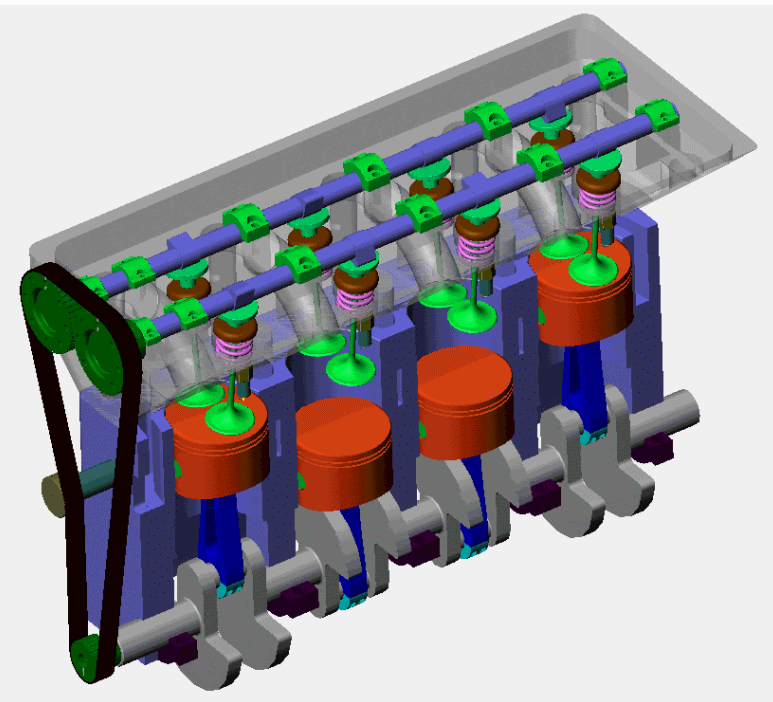



# LINHAS DE PESQUISA

## 7. Desenvolvimento de Soluções Eficientes a Partir do Biogás

- Cálculo do potencial energético e regulamentação.

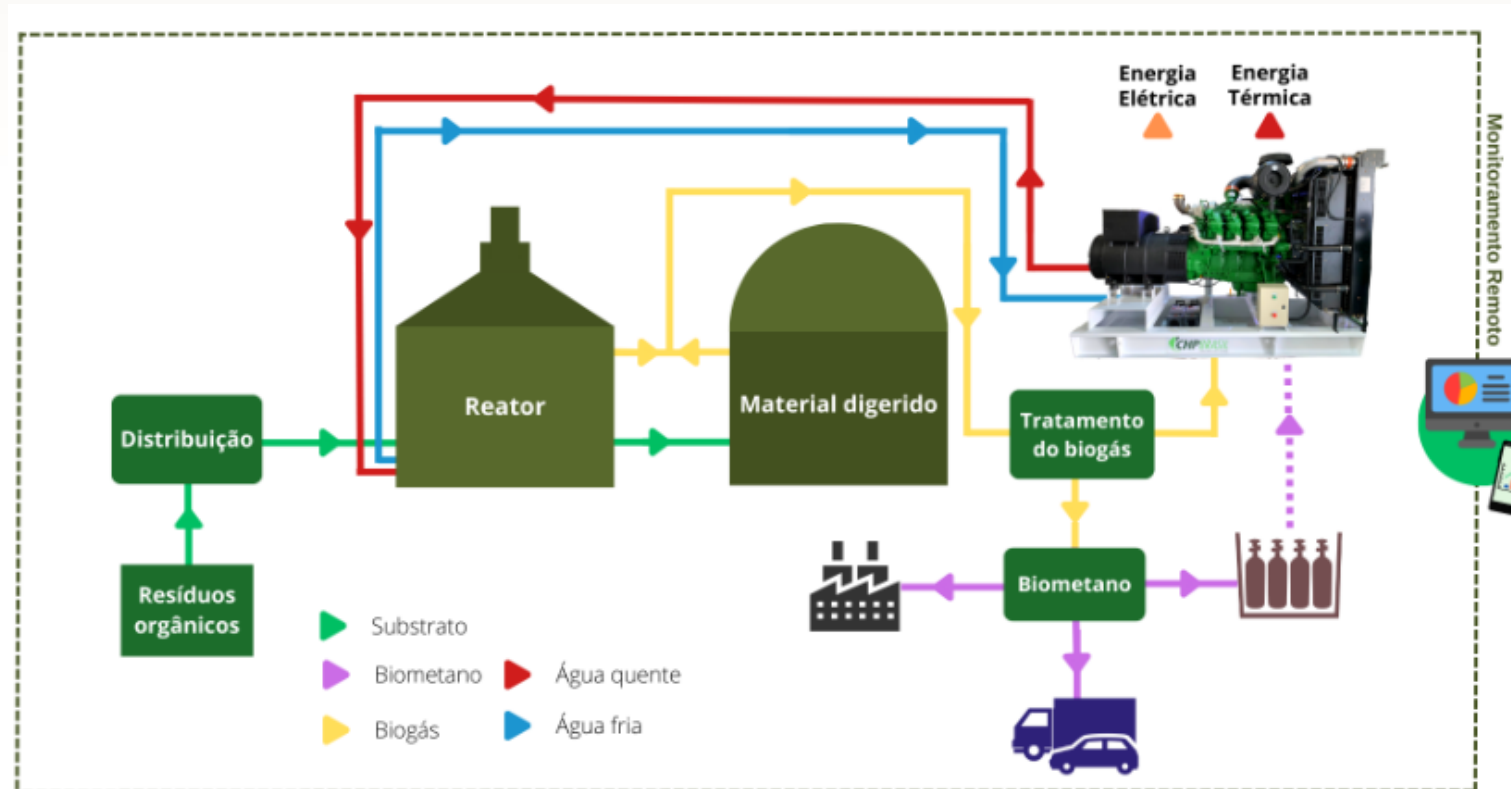

# LINHAS DE PESQUISA

## 8. Universidade Sustentável

- Diagnóstico de sustentabilidade.
- Tratamento e reuso de resíduos.

