

## Real-time neuro-fuzzy controller for pressure adjustment in water distribution systems

Hugo Augusto Marinho Moreira, Heber Pimentel Gomes, Juan Moises Mauricio Villanueva and Saulo de Tarso Marques Bezerra

### ABSTRACT

This work applied a neuro-fuzzy technique for real-time pressure control in water distribution systems with variable demand. The technique acted to control the rotation speed of the pumping system, aiming mainly at increasing energy efficiency. Fuzzy, neural and neuro-fuzzy controllers were tested in an experimental setup to compare their performances in a transient regime, a permanent regime, and with respect to disturbances applied to the system. To evaluate the efficiency of the system, a demand variation curve was emulated for different operating conditions. The results demonstrate that the neuro-fuzzy controller (NFC) presented a significant increase in pumping system efficiency and a reduction in specific energy consumption of up to 79.7% when compared to the other controllers. Target pressures were kept close to the set-point values with low hydraulic transients and maintained satisfactory stability (error <8%) under severe situations of demand variation. It is concluded that the NFC presented superior results when compared with the other analyzed controllers.

**Key words** | artificial intelligence, artificial neural networks, automation, energy efficiency, fuzzy logic, water supply

**Hugo Augusto Marinho Moreira**  
**Heber Pimentel Gomes** (corresponding author)  
**Juan Moises Mauricio Villanueva**  
 Laboratory of Energy and Hydraulic Efficiency in Sanitation,  
 Universidade Federal da Paraíba,  
 João Pessoa (PB),  
 Brazil  
 E-mail: [heberp@uol.com.br](mailto:heberp@uol.com.br)

**Saulo de Tarso Marques Bezerra**  
 Department of Technology,  
 Universidade Federal de Pernambuco,  
 Caruaru (PE),  
 Brazil

### HIGHLIGHTS

- A neuro-fuzzy controller for real-time pressure control of WDS is proposed.
- The performance of the neuro-fuzzy controller is robust.
- The effectiveness of controller has been demonstrated through experimental tests.
- Improving the efficiency of pumping systems contributes to energy conservation.
- Optimal pumping reduces up to 79.7% of the specific energy consumption.

### ABBREVIATIONS

FC	fuzzy controller	P	power consumption
H	pump head	PID	proportional-integral-derivative
K	time consumption coefficient	PRV	pressure reducing valve
NC	neural controller	Q	flow rate
NF	neuro-fuzzy	SCADA	supervisory control and data acquisition
NFC	neuro-fuzzy controller	SEC	specific energy consumption
		VFD	variable frequency drive
		VSP	variable speed pumps
		WDS	water distribution system

This is an Open Access article distributed under the terms of the Creative Commons Attribution Licence (CC BY 4.0), which permits copying, adaptation and redistribution, provided the original work is properly cited (<http://creativecommons.org/licenses/by/4.0/>).

doi: 10.2166/ws.2020.579

## INTRODUCTION

Water distribution systems (WDSs) are important infrastructure in modern society and occupy a prominent position for economic development (Geng *et al.* 2019). These systems can be defined as a set of equipment, works and services aimed at water supply for domestic, industrial and public consumption purposes. Due to their dimensions and particularities, these systems generally present a high complexity that hampers their design and operation. The demand variation, which is intrinsic to many WDSs, results in changes to the operational dynamics of pumping systems and requires the use of energy control and rationalization methods for different operating scenarios.

Energy conservation and efficiency are gaining prominence in many water utilities, mainly due to environmental regulations and increasing energy costs (Salomons & Housh 2020). Several solutions have been proposed to increase the efficiency of WDSs (Mora *et al.* 2013; Wei *et al.* 2013; Larsen *et al.* 2016; Rinas *et al.* 2018). Among these actions, pressure control is one of the main technical options used to increase the energy and hydraulic efficiency of systems (Bezerra *et al.* 2012; Campisano *et al.* 2012; Fecarotta *et al.* 2015; Sarbu 2016; Page *et al.* 2017a), which can be adjusted via the use of pressure reducing valves (PRVs), turbines, pumps as turbines, and variable speed pumps (VSPs) in response to real-time pressure sensor measurements at remote nodes (Vicente *et al.* 2016). However, PRV are designed to produce head losses.

Due to the high energy consumption of WDSs, engineering solutions that adopt variable-frequency drives (VFDs) in pumping systems have been highlighted in the literature. In this operating mode, it is possible to increase the energy efficiency of the pumps when operating at a variable speed. In practice, it is common to apply proportional-integral-derivative (PID) control techniques in WDS pumping and control valves. Designing and tuning a PID controller appears to be conceptually intuitive but can be difficult in practice if multiple (and often conflicting) objectives such as transience (period until steady-state) and high stability (ability to keep the output stable when a disturbance is inserted in the system) are to be achieved. In specific cases, systems cannot undergo major changes in their

operational conditions because of the risk that control will become unstable or require adjustments to its parameters. In addition, if a large time delay is not correctly considered in the control of a pump rotation in a large WDS, oscillations and instabilities can occur in the control process. These dilemmas have encouraged researchers to develop novel 'intelligent' tools for WDSs (Moura *et al.* 2018).

Control is defined here as a closed feedback loop in which the difference between a measured process variable and a desired set-point is minimized over time by the adjustment of a process setting (Page *et al.* 2017b). Recently, several works have been developed for the control of pumping systems using fuzzy logic (Errouha *et al.* 2019; Flores *et al.* 2019) and neural networks (Barros *et al.* 2017; Moura *et al.* 2018; Jin *et al.* 2019). However, WDSs have highly nonlinear characteristics and are directly influenced by hourly demand variations and operational changes caused by failures and stoppages for maintenance or installations. Therefore, more robust monitoring, control and operation techniques are necessary to minimize instability, increase efficiency and guarantee essential conditions to serve the final consumer in both quantity and quality.

Hybrid control techniques, such as the neuro-fuzzy (NF) technique, are widely used in several areas of engineering where mathematical problem modeling is complex. The great advantage of this method is that it does not require a mathematical model of the system (commonly used for the design of conventional controllers) or a specialist for modeling the system's rule base (necessary for the design of fuzzy controllers). In addition, NF controllers provide numerous advantages when combining the properties of artificial neural networks and fuzzy logic, such as the ability to learn, generalize and interpret. This type of control has been used in several studies due to its good performance in recent years (Ferdaus *et al.* 2019; Thangaraj & Somasundaram 2019; Ghanooni *et al.* 2020).

This work aims to develop a real-time neuro-fuzzy controller (NFC) for pumping systems as a way to control pressures under variable demand. The control acts in the variation of the rotation speed of pumping systems, changing the speed according to the needs of hourly demand to regularize the pressures of the system. The experimental setup is installed at the Laboratory of Energy and Hydraulic Efficiency in Sanitation of the Federal University of Paraíba,

Brazil. The NFC is tested and analyzed with respect to performance (permanent regime, transience and disturbances) and energy savings, as indicated by energy efficiency indicators (pumping system efficiency and specific energy consumption). To validate its performance, the designed controller is compared to fuzzy and neural controllers.

## EXPERIMENTAL SETUP

The experimental setup (Figure 1), which emulated a real WDS with variable demand, was powered by a pumping system connected to a reservoir and consisting of a three-phase 3 HP induction motor and a centrifugal pump with a maximum flow of  $12 \text{ m}^3/\text{h}$  and maximum head of 45 m. The system has a control valve to vary the demand and the operational conditions of the experimental setup. The system was driven by a VFD to control the rotation speed of the pump.

LabVIEW, a graphical programming language used to accommodate the supervisory control and data acquisition (SCADA) system in a microcomputer, was used for data acquisition and instrument control software. The SCADA system allows an operator to make the set-points change on the controller, to open/close the valve and to monitor actuators and sensors. These sensors measured pressure, flow and power consumption.

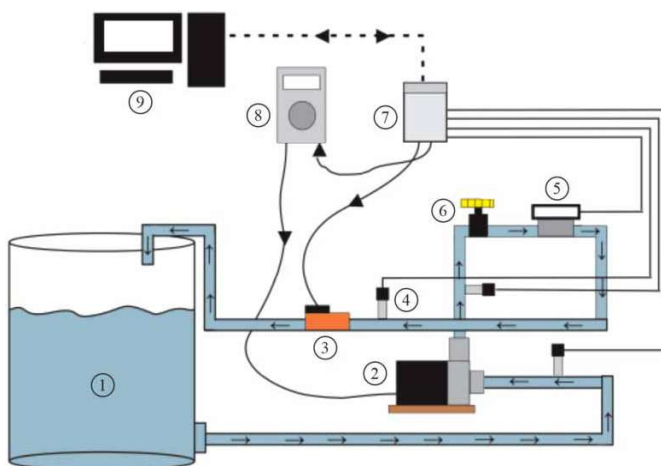

Figure 1 | Experimental setup schematic.

## NEURO-FUZZY CONTROLLER

The neuro-fuzzy controller was the hybridization result of two methods based on artificial intelligence techniques: artificial neural networks and fuzzy logic. The training adopted was supervised; thus, the elaboration of this controller involved the development of a robust database with the data parity of a pre-existing (primary) controller.

In this work, a fuzzy primary controller (FC) with the control surface illustrated in Figure 2 was proposed to control the system and generate parity of the training data. *Error* was defined as deviation from the set-point value (difference between the measured pressure and the desired

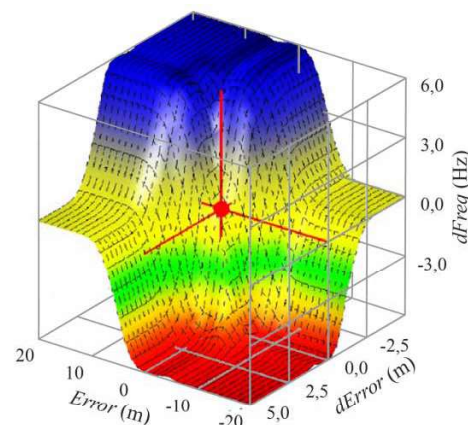

Figure 2 | Response surface of the fuzzy controller.

### LEGENDS

- 1 - Tank
- 2 - Pumping systems
- 3 - Control Valve
- 4 - Pressure transmitter
- 5 - Flow transmitter
- 6 - Manual valve
- 7 - Data acquisition system
- 8 - Variable frequency drive
- 9 - Computer

set-point), error variation ( $dError$ ) was the difference between the  $Error$  at  $k$  and  $k - 1$ , and the frequency variation ( $dFreq$ ) was the VFD output frequency at  $k$  and  $k - 1$ .

Inputs and outputs of the FC, and the linguistic variables, as well as the number and format of the membership functions (Figure 3), were selected as per literature recommendations, heuristic analysis and experimental tests. The inference method used was Mamdani's procedure based on min-max decision. The defuzzification method was the center of area method because it is the most commonly used method. With defuzzification, resultant fuzzy values of the fuzzy rules were converted into crisp values. This same controller was used in the comparative analysis in the

results section. The experimental procedure for the acquisition of the training data consisted of performing tests and varying the set-point and operating conditions, with the primary controller based on fuzzy logic.

The database was formed by the data parity of two input variables (error and error variation) and an output variable (frequency variation), as shown in Figure 4(a). Table 1 shows the system variables and how sampling occurs at time  $k$ . For the acquisition of training data, a frequency of sampling equal to 100 samples/s was used, estimating an average value for every 10 samples to reduce variations during data acquisition. In total, 5,900 data sets were used to train the neural controller (NC) and NFC. The controller

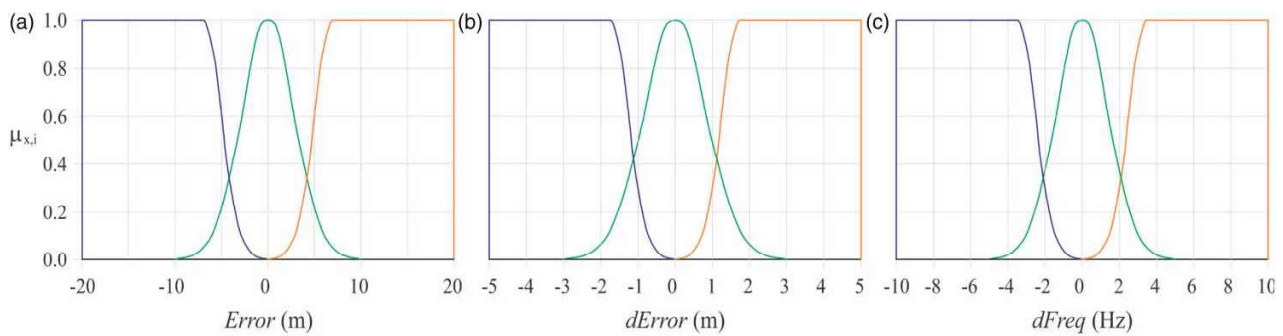

Figure 3 | Membership functions of the fuzzy controller. (a) Input linguistic variable  $Error$ . (b) Input linguistic variable  $dError$ . (c) Output linguistic variable  $dFreq$ .

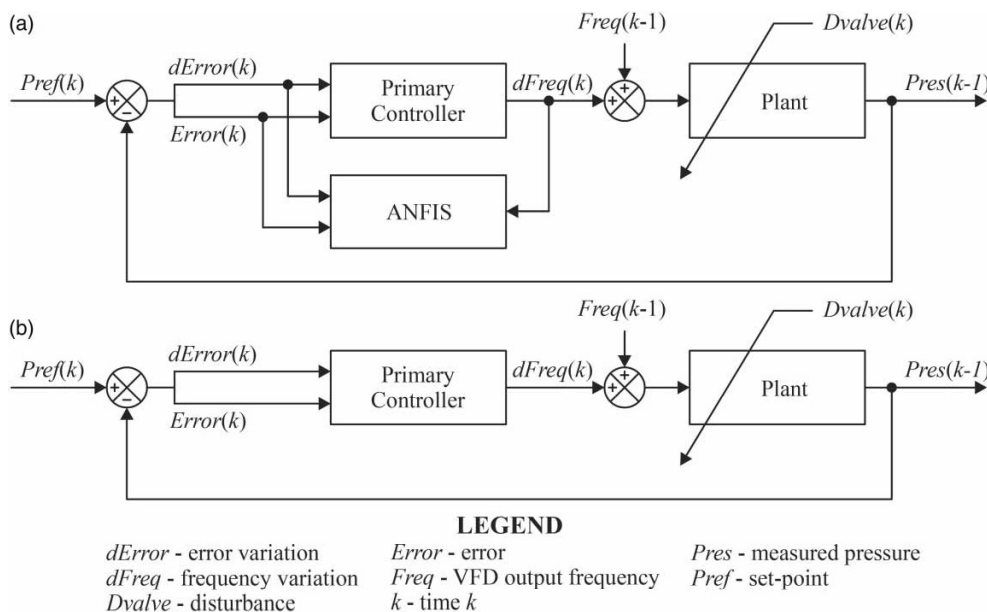

Figure 4 | Block diagrams. (a) Training structure of the NFC. (b) NFC controller structure.

**Table 1** | Dataset format

Sampling instant	Error	Error variation	Frequency variation	Estimation
$k - 1$	...	...	...	...
$k$	$e(k)$	$e(k) - e(k - 1)$	$f(k) - f(k - 1)$	Average value estimation of error and error variation for every 10 samples.
$k + 1$	$e(k + 1)$	$e(k + 1) - e(k)$	$f(k + 1) - f(k)$	
$k + 2$	$e(k + 2)$	$e(k + 2) - e(k + 1)$	$f(k + 2) - f(k + 1)$	
...	...	...	...	...
$k + 9$	$e(k + 9)$	$e(k + 9) - e(k + 8)$	$f(k + 9) - f(k + 8)$	...
$k + 10$	...	...	...	...

was based on a multilayer perceptron neural network. The network used has three layers, eight neurons in each layer and tangent activation function. The learning method adopted in the research was based on the Error backpropagation methodology, which includes dynamic learning. Figure 4(b) illustrates the closed loop control system structure for the NFC.

The artificial neural network architecture used in this work is illustrated in Figure 5. It consists of five layers, representing the training steps. The first layer calculated the membership value ( $\mu_{x,i}$ ) and the degree of relevance ( $W_1$  and  $W_2$ ) with which the entries (Error:  $X_1$  and Error variation:  $X_2$ ) satisfy the values or linguistic terms associated with these nodes. In the second layer, each node corresponded to a rule and calculated to what degree ( $A_{i,j}$ ) the consequent rule was being met; that is, the implications of the premises. The third layer was responsible for normalizing the vector, while in the fourth layer, neuron outputs were calculated using the product of the consequent rule. The respective output was calculated on the last layer (frequency variation:  $Y$ ).

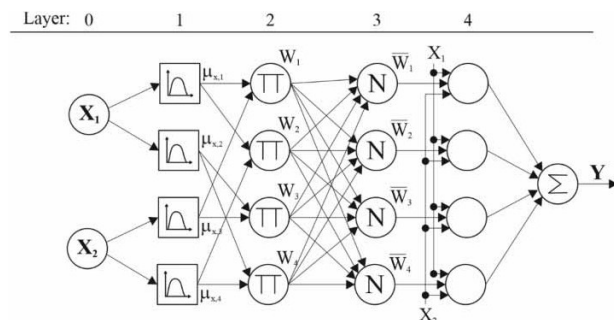

**Figure 5** | Artificial neural network architecture of the NFC.

### EVALUATION OF SYSTEM EFFICIENCY

Water distribution systems are subject to variations in water demand. This continuous change in demand is reflected in the variation in system pressures, which fluctuate throughout the day. In times of lower demand, the pumping system, which is designed to operate at a nominal rotation speed, supplies the network with excess pressure, wasting energy and causing an increase in the incidences of ruptures and leakages. The opposite is observed in times of greater demand, where the pressure will drop. To increase the efficiency of these systems, intelligent techniques are being developed for real-time pressure control of WDSs. This work adopted the demand variation curve shown in Figure 6 to assess the impacts of the controllers (Fuzzy and Neuro-Fuzzy). The daily demand pattern described the typical consumption variation throughout the day. Two of the most common performance indicators were used in the pumping systems evaluated: pumping system efficiency and specific energy consumption (Equations (1) and (2)). The energy

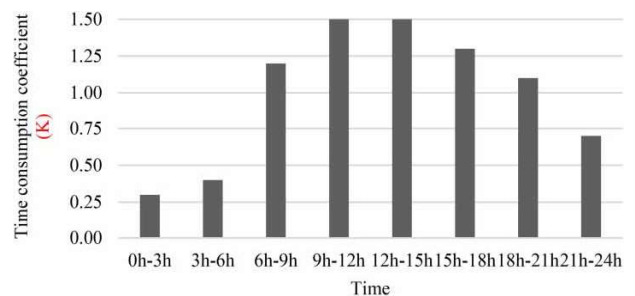

**Figure 6** | Demand variation curve. The K coefficient is a normalized vector that indicates the demand.

gain of the different control strategies was evaluated by comparing the results before and after the automation process.

Pumping system efficiency ( $\eta$ ), in decimal form, given by Equation (1):

$$\eta = (9.81 \times H \times Q) / (3600 \times P) \quad (1)$$

Specific energy consumption (SEC), in kWh/m<sup>3</sup>, given by Equation (2):

$$\text{SEC} = P/Q \quad (2)$$

where H [m] is the head of the centrifugal pump, Q [m<sup>3</sup>/s] is the flow rate and P [kW] is the power consumption.

## RESULTS AND DISCUSSION

This section contains the analysis of the experimental tests carried out in relationship to the controller and the energy efficiency indicators used to determine the energy efficiency of the system. The first experimental tests were carried out to analyze the controllers and the plant in critical conditions. The analysis of the transient and permanent regimes covered the controller's step response (NFC, FC and NC) and the stability of the system when subjected to severe

disturbances caused by the control valve. In the energy efficiency analysis, a demand variation curve was implemented to evaluate the efficiency and the specific energy consumption of the VFD-motor-pump system over a day. Then, indicators were used to account for energy gain in four scenarios: an uncontrolled system, a manually controlled system, NFC and FC.

### Building the database

The responses from the primary controller (FC) represent the training data used for the development of the NC and NFC. The criteria used to define the experimental procedures for the development of the database consisted of simplicity (represented by the responses to the step and the set-point variation) and operating conditions of the pumping system (represented by the variation in demand and pressures). As shown in Figure 7, the training was carried out by changing the opening of the control valve and for several set-points.

### Neuro-fuzzy controller analysis

Fuzzy, neural and neuro-fuzzy controllers were tested in an experimental setup to compare their performances in a transient regime, a permanent regime, and with respect to

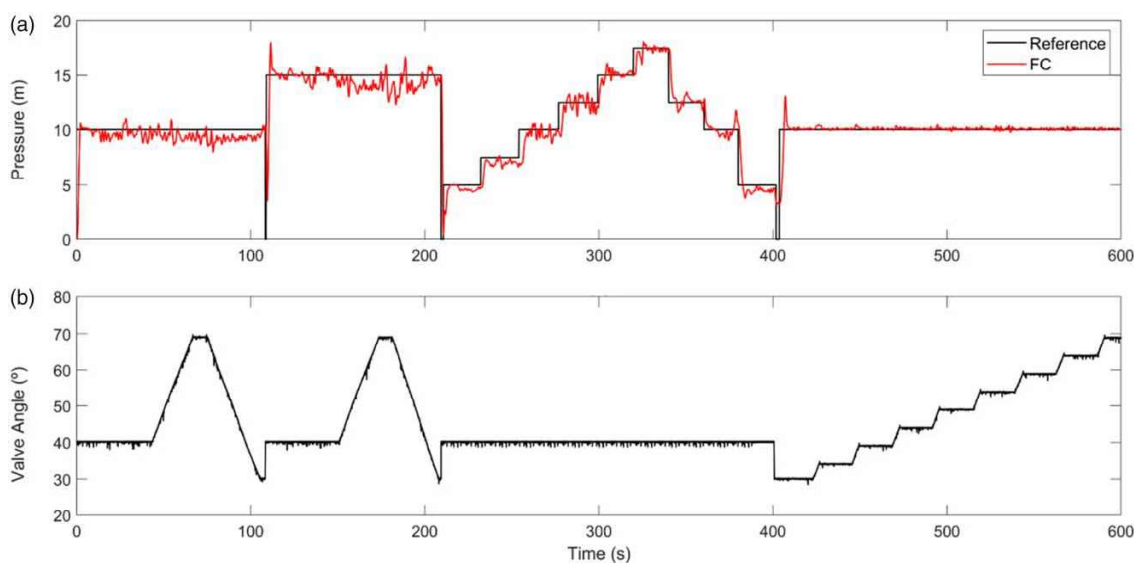

**Figure 7** | Training data. FC response to different set-point values. (a) Pressure. (b) Angle valve. The opening angle of the control valve varies from 0° (open) to 90° (closed).

disturbances applied to the system. A control system is considered robust when it is able to maintain the stability of a system even when subjected to disturbances. The first two tests were carried out with a sudden increase in the demand for water in the network; the third experimental trial adopted a milder variation in demand; the fourth assessed the controller's response to dynamic changes in the set-point; and the last test was carried out to evaluate the control response and its stability.

Figure 8 shows the dynamic response of the system for a 10 m set-point, where it is observed that the FC has the highest speed and the NC has the lowest overshoot. The NFC hybrid characteristics present intermediate speed and overshoot. Analyzing the settling time (the time taken for the system to converge to its steady-state) and stability (steady-state error), it is noted that the NFC results are superior, while the FC does not stabilize in a timely manner. After entering the steady state, the operating dynamics are changed by closing and opening the control valve. It is possible to verify that the NFC is the only one that maintains good stability, adapting to system changes with low error (error <8%). Table 2 summarizes the performance of the controllers in a transient and permanent regime for a 10 m step. The same analysis can be performed in relationship to Figure 9, in which a 15 m set-point was configured. Both controllers have non-zero overshoot; however, the NFC

presents the best performance in relationship to the steady-state error, settling time and demand variation. In water distribution systems, the importance of steady-state error and stability overrides the settling time.

For a WDS, the steady-state error is not an extremely critical factor, mainly in situations of demand variation, with tolerable errors in the order of 2 to 5%. Analyzing the performance of the controller by varying the demand slowly (Figure 10), it is possible to observe that the NFC maintains the pressures with a low percentage of error (error <3.3%), compared with 9.8% for the NC and 2.1% for the FC. The controller results also demonstrate that the power of the pumping system was stable and had no peak current, an important aspect for the protection of electro-mechanical equipment. The presence of a high peak (up to 179% higher than NFC) in power consumption for the FC shows that it can have harmful transient characteristics.

To demonstrate the controller's effectiveness at different set-points, Figure 11 shows the controller operation results

Table 2 | Controller performance analysis

Controller	Settling time (s)	Overshoot (%)	Steady-state error (%)
NFC	6.6	11.5	0.9
NC	14.6	0.0	1.2
FC	4.4	9.3	11.8

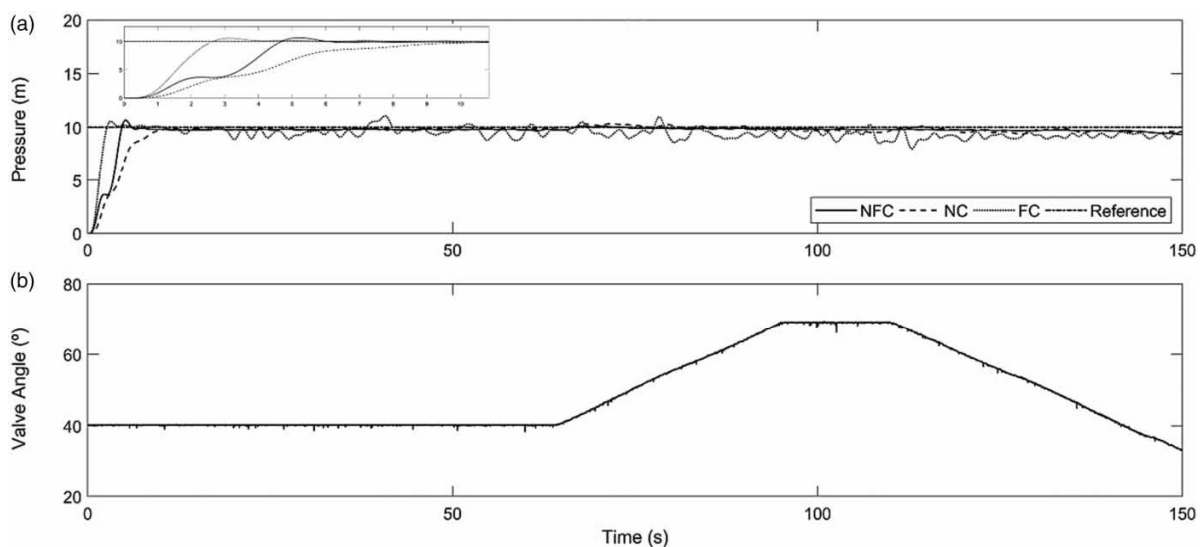
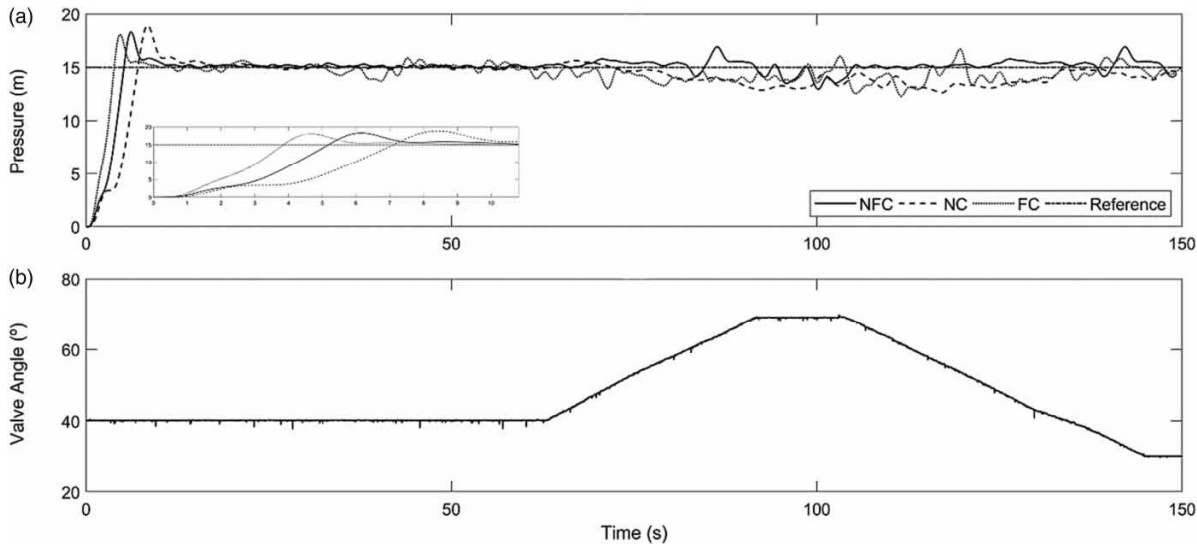
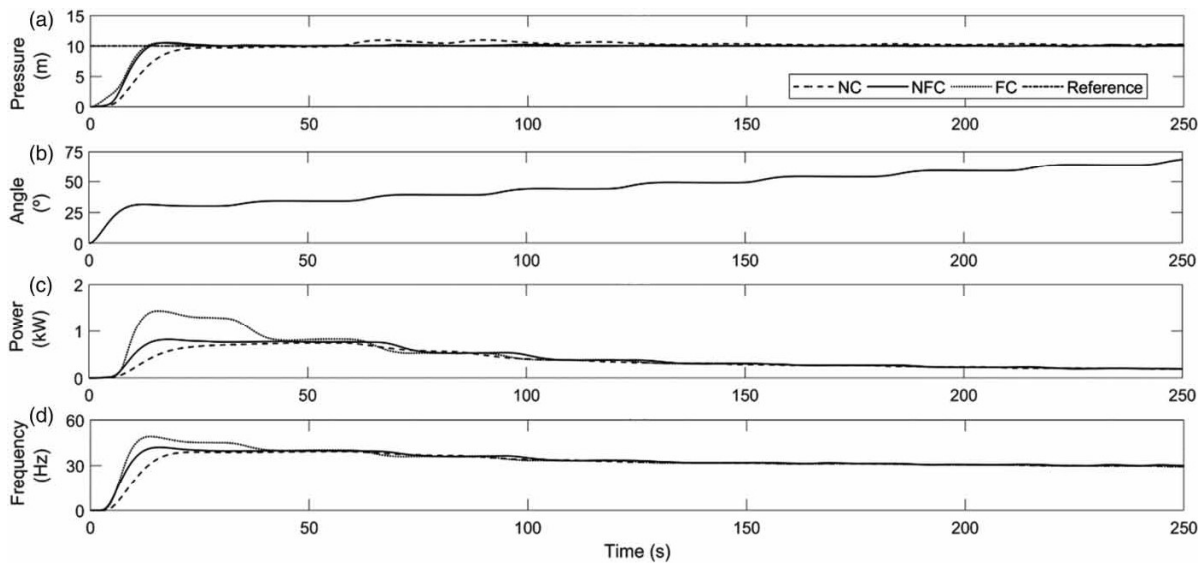

Figure 8 | Response to 10 m step signal. (a) Pressure. (b) Angle valve.



**Figure 9** | Response to 15 m step signal. (a) Pressure. (b) Angle valve.

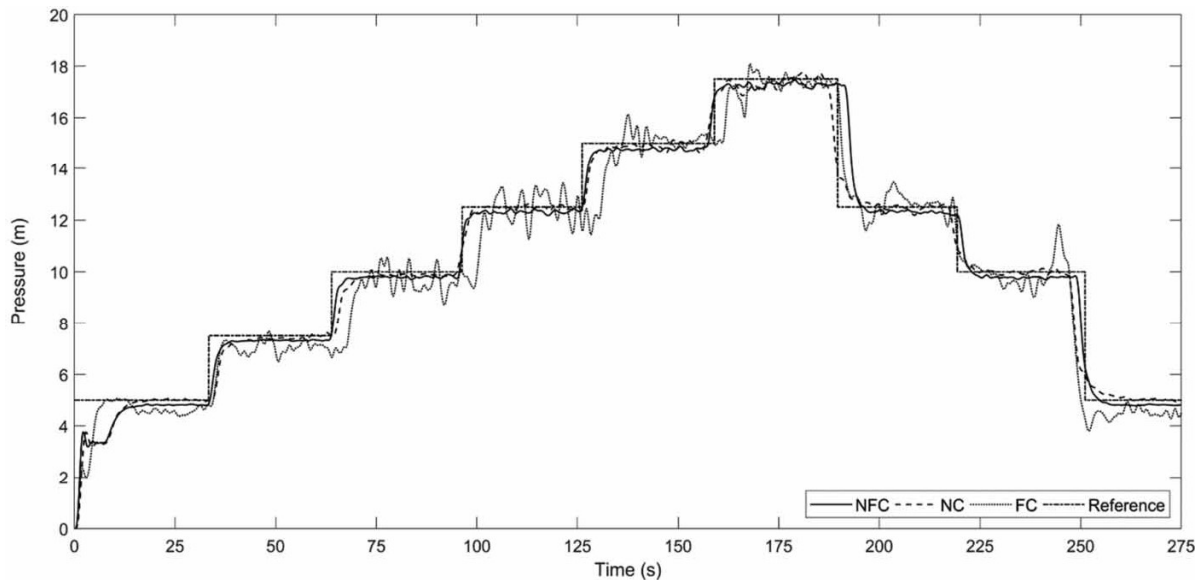

**Figure 10** | Controllers' response to changing the valve opening angle in steps. (a) Pressure. (b) Angle valve. (c) System electrical input power. (d) VFD output frequency.

with a progressive change of system pressure values (valve angle equal to  $40^\circ$ , which corresponds to the average demand for the system). It is possible to observe that, due to the repetitive change of the set-point, no controller reaches a low steady-state error when compared to the 10 m step. Graphically evaluating the rise time and stability, the NC and NFC present similar results and are superior to the FC.

Due to the adaptive characteristics of the developed control, it is expected that it adapts to more complex real systems. Although the experiment setups were simple, the operating conditions imposed in the tests occur in very short time intervals (seconds), requiring a fast and robust response from the controller. Set-point variations were tested under a number of challenging conditions (Figure 11).





**Figure 11** | Pressure behavior with the control systems subjected to several set-points.

In real systems, operational changes are often gradual and slow, which would facilitate the performance of the NFC.

### Energy efficiency analysis

To assess the energy efficiency of the system, a consumption profile was implemented in the SCADA system and four operating scenarios were tested:

- Pressure control by a FC;
- Pressure control by the NFC;
- Manual control; and
- Uncontrolled system.

The system is considered uncontrolled when there is no automatic regulation of pressure or flow. Manual control was performed by manually adjusting a valve inserted after the pump. In both scenarios, the pumping system operated at the rated speed of rotation. The efficiency of the VFD-motor-pump system for the four scenarios is shown in Figure 12. It was observed that during times of low demand (i.e. 0 h–3 h), the efficiency of the controlled system was higher than other modes of operation. As expected, the performance of the controlled system was lower during peak demand times. The increase in performance during the minimum demand mentioned was because

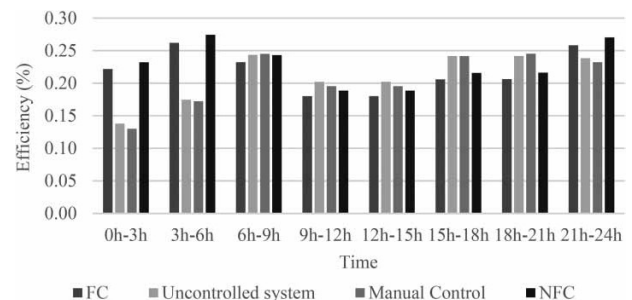

**Figure 12** | Pumping system efficiency.

the controller maintains the pressure at 10 m. For the FC, there was an average increase in efficiency of 9.16% when compared to manual control. The increase was 9.59% for NFC due to the lower control action, reflecting the greater stability and energy efficiency. When the system operated with the pump at nominal speed (uncontrolled system) and demand was controlled by valve (manual control), there was a pressure drop at the end user due to the excess pressure loss caused by the valve, negatively affecting the overall system performance.

Figure 13 shows the behavior of specific energy consumption, where it is evident that FC and NF show better results than the other two methods. In the period evaluated, from 9:00 am to 2:59 pm, SEC equality is observed in the four methods adopted because, in all cases, the system

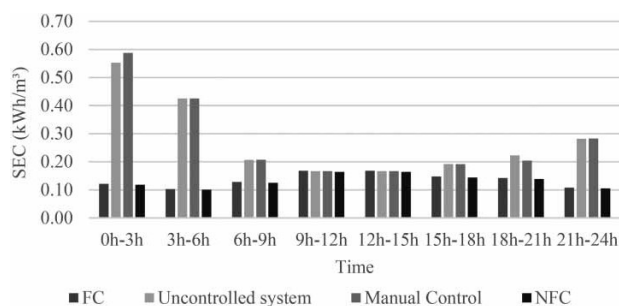

Figure 13 | Specific energy consumption.

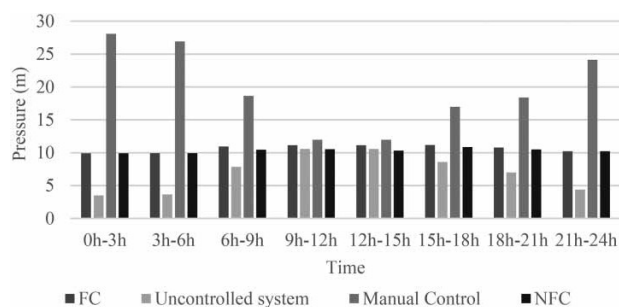

Figure 14 | Average system pressures with variable demand.

operates at nominal rotation speed. In addition, a maximum reduction of 79.3% is observed at 00:00 when comparing the system operating with the FC to the system without control. Comparing the NFC to the uncontrolled system, the result is even better, reaching a 79.7% reduction, showing that it can reduce the energy consumption by approximately five times.

The behavior of the pressure of the system over 24 h was also investigated for each of the four operating scenarios proposed in this research, whose results are shown in Figure 14. For the NFC, the average pressure was 10.3 m, and for the fuzzy controller, the average pressure was 10.7 m, with errors of 3 and 7%, respectively. It was also found that the system without a controller presented the greatest pressures during periods of least demand. This could cause the rupture of pipes, increase water loss by leaks and reduce operational efficiency.

## CONCLUSIONS

The application of control systems in water distribution systems (WDS) can allow for a significant increase in the

effectiveness, efficiency and reliability of pumping systems, thus providing lower operating costs. The operation is defined on the basis of the real demand, which makes the most efficient use of the available water while supporting conservation and environmental efforts.

This work aimed to implement a recent and innovative control technique for WDSs aimed at energy efficiency and pressure control. Neural and neuro-fuzzy controllers (NC and NFC) were trained from a database built using a fuzzy primary controller. The controllers were tested experimentally under different operating conditions, including in the presence of disturbances. The results showed that the NC and NFC presented the best performances for the experimental setup. This was because the controllers obtained by computational modeling were based directly on the dynamics of the plant. Thus, even if the data are inaccurate or noisy, the controllers derived from these techniques will have the ability to control the system with greater robustness and performance. This is one of the great advantages of an NFC – it allows for more efficient controllers to be designed from poorly designed and/or inefficient controllers.

The energy efficiency analysis showed that there was a significant reduction in energy consumption and in the specific energy consumption of the pumping system when comparing the NFC to other controllers. The results demonstrated that the neuro-fuzzy controller (NFC) presented a significant increase in pumping system efficiency and a reduction in specific energy consumption of up to 79.7% compared to the other controllers. Target pressures were kept close to the set-point values and with low hydraulic transients, in addition to satisfactory stability (error <8%) in severe situations of demand variation. Finally, it is concluded that the NFC presented superior results when compared with the other analyzed controllers.

## ACKNOWLEDGEMENTS

This research was supported by Centrais Elétricas Brasileiras SA (Eletrobras) and the Brazilian Coordination for the Improvement of Higher Education Personnel (Coordenação de Aperfeiçoamento de Pessoal de Nível Superior, CAPES).

## DATA AVAILABILITY STATEMENT

All relevant data are included in the paper or its Supplementary Information.

## REFERENCES

- Barros, E. G. F., Salvino, L. R., Bezerra, S. T. M., Salvino, M. M. & Gomes, H. P. 2017 **Intelligent system for control of water distribution networks**. *Water Science & Technology: Water Supply* **18** (4), 1–12. <https://doi.org/10.2166/ws.2017.188>.
- Bezerra, S. T. M., Silva, S. A. & Gomes, H. P. 2012 **Operational optimisation of water supply networks using a fuzzy system**. *Water SA* **38** (4), 565–572. <https://doi.org/10.4314/wsa.v38i4.12>.
- Campisano, A., Modica, C. & Vetrano, L. 2012 **Calibration of proportional controllers for the RTC of pressures to reduce leakage in water distribution networks**. *Journal of Water Resources Planning and Management* **138** (4), 377–384. [https://doi.org/10.1061/\(ASCE\)WR.1943-5452.0000197](https://doi.org/10.1061/(ASCE)WR.1943-5452.0000197).
- Errouha, M., Derouich, A., Motahhir, S., Zamzoum, O., El Ouanjli, N. & El Ghizal, A. 2019 **Optimization and control of water pumping PV systems using fuzzy logic controller**. *Energy Reports* **5**, 853–865. <https://doi.org/10.1016/j.egyr.2019.07.001>.
- Fecarotta, O., Aricò, C., Carravetta, A., Martino, R. & Ramos, H. M. 2015 **Hydropower potential in water distribution networks: pressure control by PATs**. *Water Resources Management* **29** (3), 699–714. <https://doi.org/10.1007/s11269-014-0836-3>.
- Ferdous, M. M., Pratama, M., Anavatti, S. G., Garratt, M. A. & Lughofer, E. 2019 **PAC: A novel self-adaptive neuro-fuzzy controller for micro aerial vehicles**. *Information Sciences* **512**, 481–505. <https://doi.org/10.1016/j.ins.2019.10.001>.
- Flores, T. K., Villanueva, J. M. & Catunda, S. Y. 2019 **Fuzzy pressure control system in water supply networks with series-parallel pumps**. In *2019 IEEE International Instrumentation and Measurement Technology Conference*. IEEE, pp. 1–6. <https://doi.org/10.1109/I2MTC.2019.8827139>.
- Geng, Z., Hu, X., Han, Y. & Zhong, Y. 2019 **A novel leakage-detection method based on sensitivity matrix of pipe flow: case study of water distribution systems**. *Journal of Water Resources Planning and Management* **145** (2), 04018094. [https://doi.org/10.1061/\(ASCE\)WR.1943-5452.0001025](https://doi.org/10.1061/(ASCE)WR.1943-5452.0001025).
- Ghanooni, P., Yazdani, A. M., Mahmoudi, A., MahmoudZadeh, S., Movahed, M. A. & Fathi, M. 2020 **Robust precise trajectory tracking of hybrid stepper motor using adaptive critic-based neuro-fuzzy controller**. *Computers & Electrical Engineering* **81**, 106535. <https://doi.org/10.1016/j.compeleceng.2019.106535>.
- Jin, R., Huang, H., Li, L., Zhu, L. & Liu, Z. 2019 **Energy saving strategy of the variable-speed variable-displacement pump unit based on neural network**. *Procedia CIRP* **80**, 84–88. <https://doi.org/10.1016/j.procir.2019.01.108>.
- Larsen, T., Arensman, M. & Nerup-Jensen, O. 2016 **Including pressure measurements in supervision of energy efficiency of wastewater pump systems**. *Journal of Hydraulic Engineering* **142** (2), 04015048. [https://doi.org/10.1061/\(ASCE\)HY.1943-7900.0001072](https://doi.org/10.1061/(ASCE)HY.1943-7900.0001072).
- Mora, M., Vera, J., Rocamora, C. & Abadia, R. 2013 **Energy efficiency and maintenance costs of pumping systems for groundwater extraction**. *Water Resources Management* **27** (12), 4395–4408. <https://doi.org/10.1007/s11269-013-0423-z>.
- Moura, G. A., Bezerra, S. d. T. M., Gomes, H. P. & Silva, S. A. 2018 **Neural network using the Levenberg-Marquardt algorithm for optimal real-time operation of water distribution systems**. *Urban Water Journal* 1–8. <https://doi.org/10.1080/1573062X.2018.1539503>.
- Page, P. R., Abu-Mahfouz, A. M. & Mothetha, M. L. 2017a **Pressure management of water distribution systems via the remote real-time control of variable speed pumps**. *Journal of Water Resources Planning and Management* **143** (8), 04017045. [https://doi.org/10.1061/\(ASCE\)WR.1943-5452.0000807](https://doi.org/10.1061/(ASCE)WR.1943-5452.0000807).
- Page, P. R., Abu-Mahfouz, A. M. & Yoyo, S. 2017b **Parameter-less remote real-time control for the adjustment of pressure in water distribution systems**. *Journal of Water Resources Planning and Management* **143** (9), 04017050. [https://doi.org/10.1061/\(ASCE\)WR.1943-5452.0000805](https://doi.org/10.1061/(ASCE)WR.1943-5452.0000805).
- Rinas, M., Traenckner, J. & Koegst, T. 2018 **Erosion characteristics of raw sewage: investigations for a pumping station in northern Germany under energy efficient pump control**. *Water Science and Technology* **78** (9), 1997–2007. <https://doi.org/10.2166/wst.2018.474>.
- Salomons, E. & Housh, M. A. 2020 **Practical optimization scheme for real-time operation of water distribution systems**. *Journal of Water Resources Planning and Management* **146** (4), 04020016. [https://doi.org/10.1061/\(ASCE\)WR.1943-5452.0001188](https://doi.org/10.1061/(ASCE)WR.1943-5452.0001188).
- Sarbu, I. A. 2016 **Study of energy optimisation of urban water distribution systems using potential elements**. *Water* **8** (12), 1–19. <https://doi.org/10.3390/w8120593>.
- Thangaraj, V. & Somasundaram, M. S. B. 2019 **NFC-ARP: Neuro-fuzzy controller for adaptive resource provisioning in virtualized environments**. *Neural Computing and Applications* **31** (11), 7477–7488. <https://doi.org/10.1007/s00521-018-3528-8>.
- Vicente, D. J., Garrote, L., Sánchez, R. & Santillán, D. 2016 **Pressure management in water distribution systems: current status, proposals, and future trends**. *Journal of Water Resources Planning and Management* **142** (2), 04015061. [https://doi.org/10.1061/\(ASCE\)WR.1943-5452.0000589](https://doi.org/10.1061/(ASCE)WR.1943-5452.0000589).
- Wei, C. C., Hsu, N. S. & Huang, C. L. 2013 **Two-stage pumping control model for flood mitigation in inundated urban drainage basins**. *Water Resources Management* **28** (2), 425–444. <https://doi.org/10.1007/s11269-013-0491-0>.